

REVISIONS

LTR	DESCRIPTION	DATE	REV.	CHKD.	APVD.
△x1	加註共面度管制	2006.08.23	YANGZHIBIN	BILL	BILL
△x3	依ECR NO.C03090076進行修正	2009.05.12	MIMO	JACKY	DICK
△x3	依簽呈字號C803001進行修正	2009.05.12	MIMO	JACKY	DICK

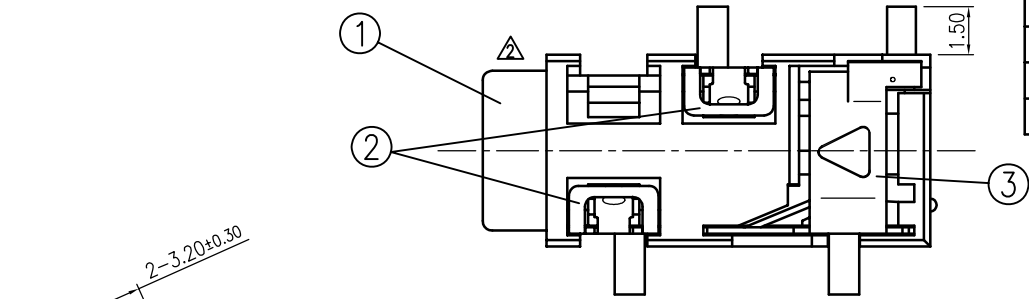

△ All Pin Terminals Must Keep Max. 0.1 Discrepancy

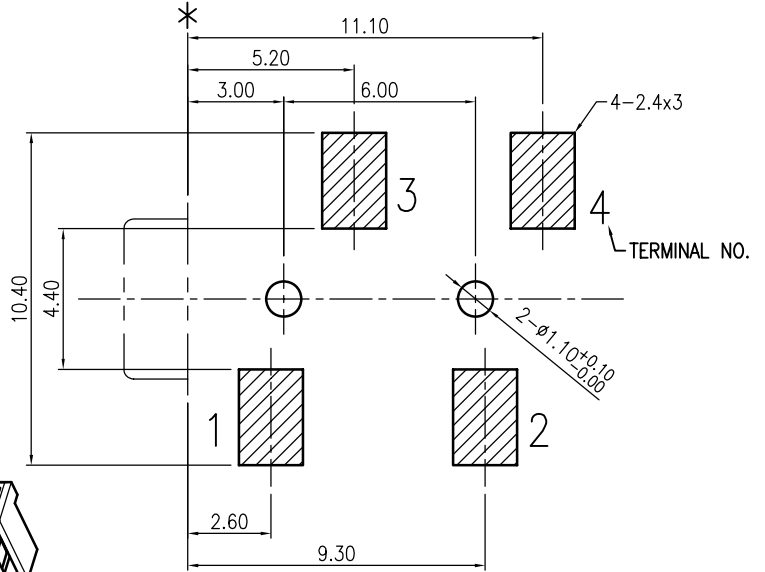
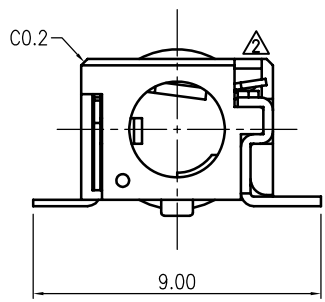
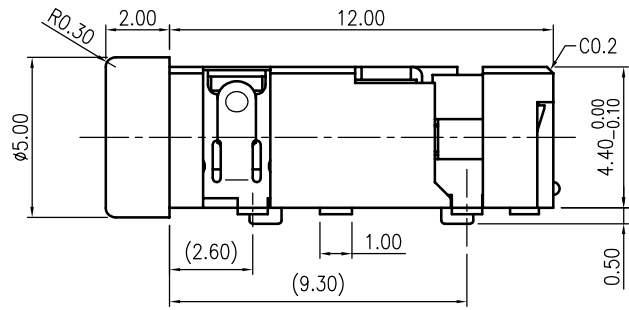

P.C.B Layout Dimension (Tolerance: ±0.1)
(Recommend min. Dimension) (Top View)

△ : Pad Area
△ : Keep Out Area

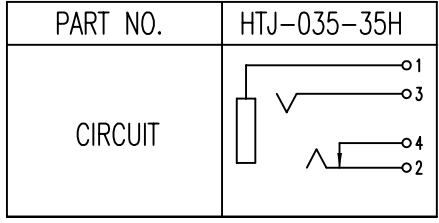
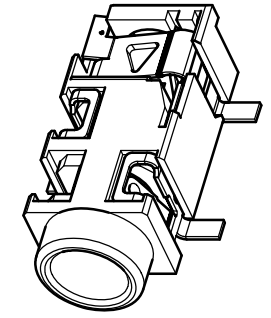
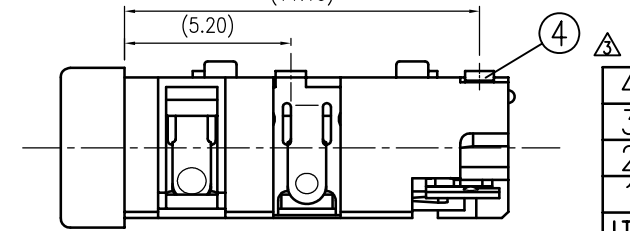
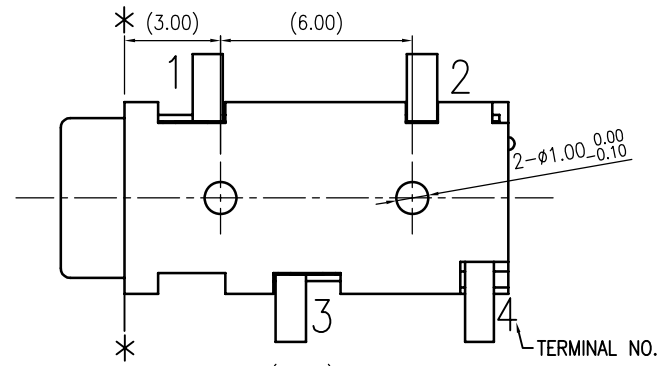
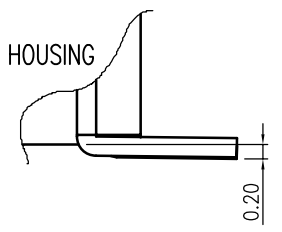

4	BREAK TERMINAL	1	Brass	t=0.30
3	TIP SPRING	1	Copper Alloy	t=0.20
2	CONTACT	2	Copper Alloy	t=0.20
1	HOUSING	1	High Temperature Thermoplastic	

Please refer color combination list.

LTR	PART NO.	QTY	MATERIAL	REMARK
120~315	±0.5	DWN	YANGZHIBIN	DATE 2006.08.23
30~120	±0.35	DSND		DATE
6~30	±0.22	CHKD	BILL	DATE 2006.08.23
BELOW 6	±0.16	APVD	Johnson	DATE 2006.08.23

NAME	MINIATURE JACK
CAT. NO.	HTJ-035-35H
DWN.NO.	A-03535H

UNLESS OTHERWISE SPECIFIED, TOLERANCE ON DECIMAL: ±0.3 FRACTIONS: ±5'