

REVISIONS					
LTR	DESCRIPTION	DATE	REV.	CHKD.	APVD.

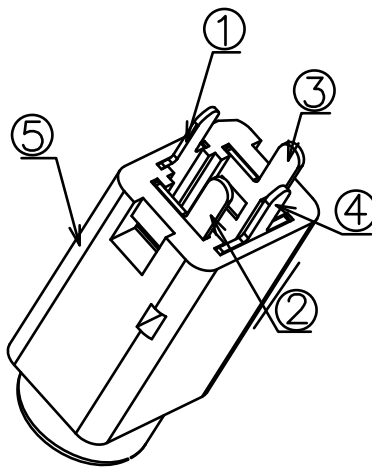
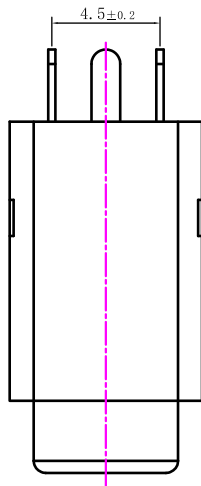
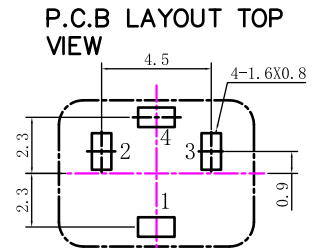
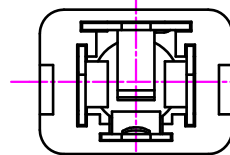
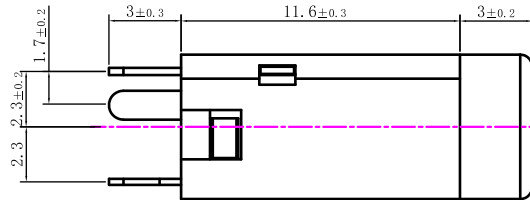
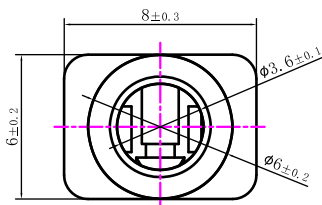

NOTES:

- CONTACT CURRENT RATING: DC 12V 1A.
- CONTACT RESISTANCE: 50 mΩ MAX.;
- INSULATION RESISTANCE: 100MΩ MIN.;
- DIELECTRIC WITHSTANDING: 500V AC MIN.;
- DURABILITY: 5,000 CYCLES MIN.;
- CONNECTOR MATING FORCES: 29.4N (3.00Kgf) MAX.;
- CONNECTOR UNMATING FORCES: 2.94N(0.30Kgf) MIN.;
- OPERATING TEMP: -30°C TO +70°C
- STORAGE TEMP: -40°C to 85°C

LTR	PART NAME	QTY	MATERIAL(THICK,COLOR)	REMARK
5	HOUSING	1	PBT 4815 UL-94V0	Black
4	TRANSFER SPRING	1	PHOSPHOR BRONZE t=0.3	SN-Plated
3	RING SPRING	1	PHOSPHOR BRONZE t=0.3	SN-Plated
2	TIP SPRING	1	PHOSPHOR BRONZE t=0.3	SN-Plated
1	EARTH SPRING	1	PHOSPHOR BRONZE t=0.3	SN-Plated

Matching Plug

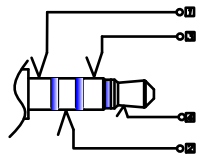

SCHEMATIC

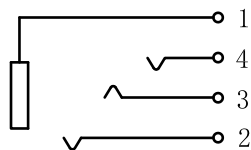

120~315	±0.50	DWN	王名正	DATE	2019.07.08	SCALE 3.125/1 PROJECTION UNIT:mm	NAME Ø3.5mm PHONE JACK CAT. NO. KM35PJV001
30~120	±0.35	DSND	王名正	DATE	2019.07.08		
6~30	±0.22	CHKD	李阮龍	DATE	2019.07.08		
BELOW 6	±0.16	APVD	郭遠峰	DATE	2019.07.08		
DIMENSION	TOLERANCE	KUNMING ELECTRONICS CO.,LTD.				DWN.NO. A-35PJV001	1/1 001